

# Contents

<b>1 Instructions</b>	<b>4</b>
<b>2 Description</b>	<b>9</b>
2.1 General Description	9
2.2 Parts definition	9
2.3 Control panel	10
2.4 Available accessories	11
<b>3 Use</b>	<b>13</b>
3.1 Instructions	13
3.2 Preliminary operations	13
3.3 First use	13
3.4 Using the accessories	15
3.5 Using the refrigerator compartment	17
3.6 Using the freezer compartment	18
3.7 Noises during operation	19
3.8 Heated front surface	19
3.9 Turning the appliance off	19
3.10 Food storage advice	20
<b>4 Cleaning and maintenance</b>	<b>22</b>
4.1 Instructions	22
4.2 Cleaning the appliance	22
4.3 Defrosting	23
4.4 Replacing the lamp	23
4.5 What to do if...	24
<b>5 Installation</b>	<b>26</b>
5.1 Unpack the refrigerator	26
5.2 Positioning	27
5.3 Electrical connection	28

We advise you to read this manual carefully, which contains all the instructions for maintaining the appliance's aesthetic and functional qualities.

For further information on the product: [www.smeg.com](http://www.smeg.com)



# Instructions

## 1 Instructions

### Important Safety Instructions

**WARNING:** If the instructions contained in this manual are not followed precisely, fire or explosion may result causing property damage, personal injury or loss of life.



**READ AND SAVE THESE INSTRUCTIONS** - Your safety and the safety of others are very important.

We have provided many important safety messages throughout this manual and on the appliance.

Read all the instructions before using the appliance and always obey all safety messages.



#### **RECOGNIZE SAFETY INFORMATION**

This is a safety alert symbol. This symbol alerts you to potential hazards that can result in severe personal injury or loss of life.

#### **UNDERSTAND SIGNAL WORDS**

A signal word - DANGER, WARNING or CAUTION - is used with the safety alert symbol. DANGER denotes the most serious hazards. It means you could lose your life or be seriously injured if you do not immediately follow the instructions. WARNING means you could lose your life or be seriously injured if the instructions are not followed. CAUTION indicates a potentially hazardous situation which, if not avoided, could result in minor to moderate injury.

#### **WARNING**



- This appliance is intended for use in the home only.
- Use this appliance only for its intended purpose. The manufacturer cannot be held liable for damage caused by improper use of this appliance.
- This appliance complies with current safety regulations. Improper use of this appliance can result in personal injury and material damage.
- Read all the instructions before installing or using the appliance for the first time.
- Keep these operating instructions in a safe place and pass them on to any future user.

# Instructions



The safety messages will inform you of potential hazards, on how to avoid the risk of injury and what can occur if the instructions are not followed.

**IMPORTANT: Observe all codes and ordinances in force.**

**WARNING: For your safety, the instructions contained in this manual must be followed to minimize the risk of fire or explosion and to prevent property damage, personal injury or loss of life.**

Do not store or use gasoline or other flammable vapors, liquids or materials near this or any other appliance.



**NOTE:** This appliance is NOT designed for installation in manufactured (mobile) homes or in recreational vehicles (RVs).

**DO NOT install this appliance outdoors.**

## WARNING



**To reduce the risk of fire, electrical shock, personal injury, or damage when using the appliance, follow basic safety precautions, including the following:**

- Read all instructions.
- Proper installation is your responsibility. Have a qualified technician install and ground this appliance in accordance with these installation instructions.
- It is the responsibility of the installer to comply with installation information specified on the model/serial ID plate. The ID plates are visibly located on the back of the appliance and on the refrigerator door frame. These ID plates must never be removed.
- Proper installation is your responsibility. Make sure your appliance is properly installed and grounded by a qualified installer.
- Use two or more people to move and install refrigerator.
- Do not climb, stand or hang on the shelves in the refrigerator. This could cause serious injury or result in damage to the refrigerator.
- **DO NOT LEAVE CHILDREN UNATTENDED:** Children should not be left alone or unattended in the area where the appliance is being used. Never allow children to sit or stand on any part of the appliance.
- Never allow children to play with the refrigerator and use the drawers, shelves and others parts of the appliance only as described in this handbook.



## Instructions

- **CAUTION:** Do not store items of interest to children in cabinets above a range or on the backguard of a range - children climbing on the range to reach items could be seriously injured.
  - **WEAR PROPER APPAREL:** Loose-fitting or hanging garments should never be worn while using the appliance.
  - For safety reasons and to avoid damage to your appliance, never sit, stand or lean on the refrigerator door.
  - Never store explosive or flammable substances, such as gasoline in or in the vicinity of this refrigerator or use gasoline or other flammable vapors or liquids in the vicinity of this or any other appliance. Read product labels for warnings regarding flammability and other hazards. **FAILURE TO DO SO CAN RESULT IN DEATH, EXPLOSION OR FIRE.**
  - Use nonflammable cleaner.
  - High alcohol drinks must only be stored sealed and vertical.
  - Never touch frozen product straight from the freezer or put it in your mouth. This can cause burn injury due to very low temperatures.
  - Unplug your refrigerator before cleaning and making repairs.
  - Disconnect power before installing ice maker (on ice maker kit ready models only).
  - Do not leave the packing materials around the home. Sort the various items of waste and take them to the nearest specialized waste collection facility.
  - **ELECTRICAL GROUNDING IS REQUIRED.** It is the customer's responsibility:
    1. To contact a qualified electrician.
    2. To ensure that the electrical system is adequate and in compliance with the National Electrical Code ANSI / NFPA 70 Electrical Code – latest edition – or the CANADIAN ELECTRICAL CODE, C22.11 – 1982 and C22.2 No. 01982 – or latest edition – and all local codes and ordinances.
  - Do not attempt to repair or replace any part of this appliance unless specifically recommended in this manual. All other servicing should be done by a qualified technician.
- To reduce the risk of fire, electric shock, or injury to persons when using this refrigerator, follow basic precautions, including the following:
- The power cord to this appliance is equipped with a three-prong grounding plug for your protection against electrical shock hazards. It must be plugged directly into a properly grounded three-prong receptacle.
  - Do not, under any circumstances, cut or remove the third (ground) prong from the power cord. For personal safety, this appliance must be properly grounded.
  - Have the wall outlet and circuit checked by a qualified electrician to make sure the outlet is properly grounded.
  - Do not use an adapter plug.
  - Do not use an extension cord.



- Never unplug an appliance by pulling on the power cord. Always grip the plug firmly and pull straight out from the outlet to prevent damaging the power cord.
- Unplug the refrigerator before servicing.
- **ONLY QUALIFIED SERVICE PERSONNEL SHOULD PERFORM REPAIRS.** Service personnel must disconnect the power supply before servicing this unit.

## State of California Proposition 65 Warning



### WARNING

This product can expose you to chemicals including vinyl chloride, which is known to the State of California to cause cancer and birth defects or other reproductive harm. For more information go to [www.P65Warnings.ca.gov](http://www.P65Warnings.ca.gov).

- Do Not Use Water on Grease Fires - Smother fire or flame or use dry chemical or foam-type extinguisher.
- Record the Model and Serial number on Page 2 of this booklet. The Model and Serial numbers are on the appliance ID plate. The ID plates are visibly located on the refrigerator door frame. **THE ID PLATE MUST NOT BE REMOVED.**
- **CHILD ENTRAPMENT HAZARD:** Child entrapment and suffocation are not problems of the past. Junked or abandoned refrigeration products are still dangerous – even if they will sit for “just a few days.” If you are getting rid of your old appliance, please follow these instructions to help prevent accidents.



# Instructions

Before you throw away your old refrigerator/freezer:

- Remove doors;
- Leave shelves in place so children may not easily climb inside;
- Have refrigerant removed by a qualified service technician.
- Destroy or recycle the carton, plastic bags, and any exterior wrapping material immediately after the refrigerator is unpacked. Children should NEVER use these items to play. They can cause suffocation and death.
- Do not allow children to climb, stand or hang on the shelves in the refrigerator.
- Never allow children to play with the refrigerator.

## How to read the user manual

This user manual uses the following reading conventions:

### Instructions



General information on this user manual, on safety and final disposal.

### Description



Description of the appliance and its accessories.

### Use



Information on the use of the appliance and its accessories, cooking advice.

### Cleaning and maintenance



Information for proper cleaning and maintenance of the appliance.



Safety instructions



Information



Advice

1. Use instruction sequence.

- Single use instruction.

# SAVE THESE INSTRUCTIONS



## 2 Description

### 2.1 General Description

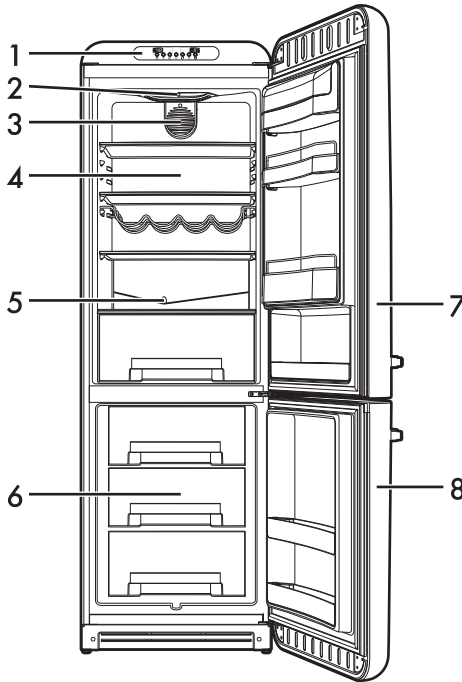

1 Control panel

2 Light

3 Fan

4 Refrigerator compartment

5 Defrost water outlet

6 Freezer compartment

7 Refrigerator door

8 Freezer door

### 2.2 Parts definition

#### Control panel

For setting the temperature inside the refrigerator and freezer compartments.

#### Interior lighting

The interior of the appliance is lit when the door is opened.

#### Refrigerator compartment

For storing fresh foods.



# Description

## Fan

Distributes the temperature and reduces condensation on the shelves and other surfaces.

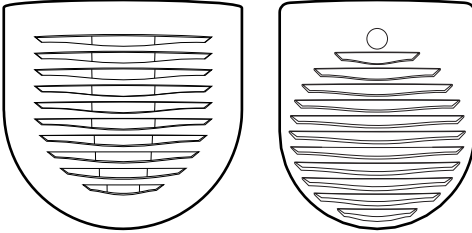

## Freezer compartment

For storing frozen foods, freezing fresh foods and producing ice cubes.



Electric energy consumption rises when the fan is operating.

## 2.3 Control panel

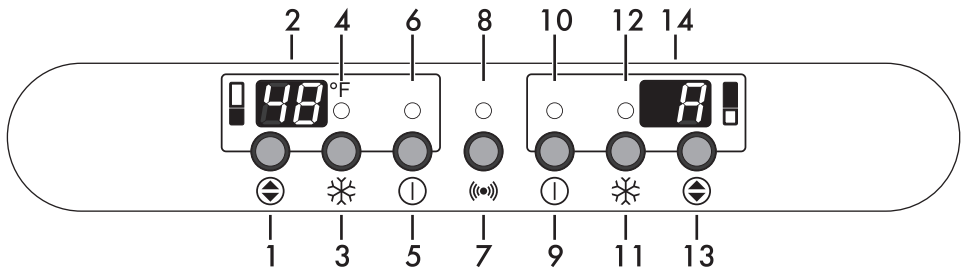

- 1 Freezer temperature button
- 2 Temperature display
- 3 Freezer Super Freeze button
- 4 Freezer Super Freeze light
- 5 Freezer ON/OFF button
- 6 Freezer ON/OFF light
- 7 Alarm button

- 8 Alarm light
- 9 Refrigerator ON/OFF button
- 10 Refrigerator ON/OFF light
- 11 Refrigerator Super Cool button
- 12 Refrigerator Super Cool light
- 13 Refrigerator temperature button
- 14 Compartment display





## 2.4 Available accessories



Some models are not provided with all accessories.

### Shelves

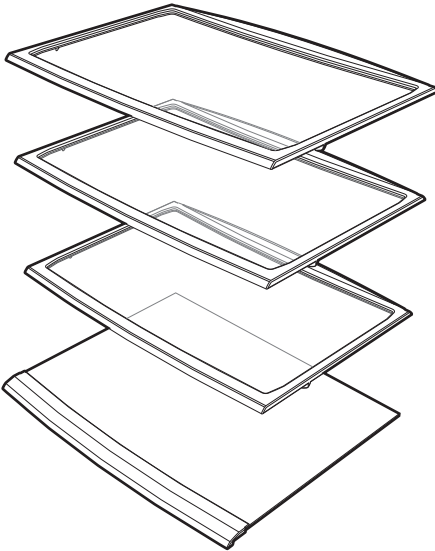

For optimising refrigerator space and placing foodstuffs inside the refrigerator compartment.

### Bottle rack

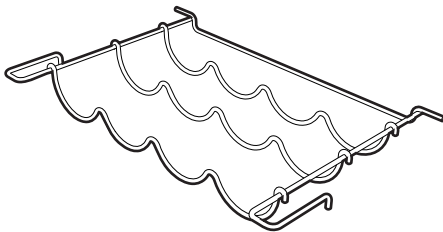

For storing bottles inside the refrigerator compartment.

### Fruit and vegetable drawer

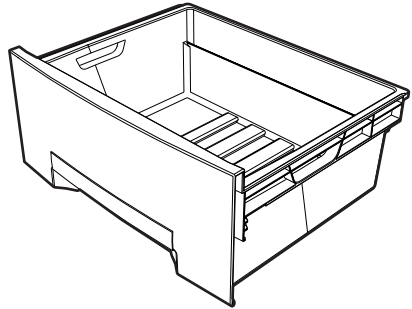

For storing fruit and vegetables, maintaining a constant humidity level.

### Freezer drawers

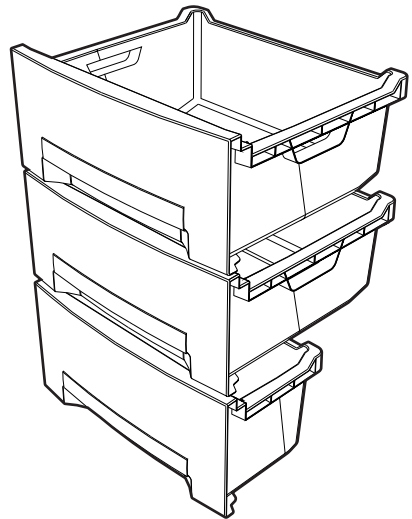

For storing frozen foods and foods to be frozen.



## Description

### Door balconies and shelves

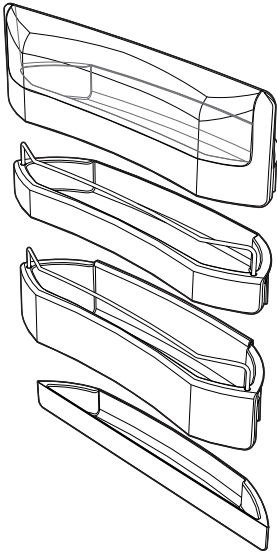

For storing foodstuffs in small containers. The shelf in the lower part of the door is useful for storing bottles. In some models, the internal part of the freezer door is also fitted with balconies for frozen foods which are handled more frequently (e.g. ice cream, already opened bags etc.)

### Egg holder

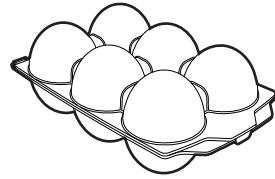

Useful for storing eggs, this can be positioned in various balconies and shelves in the freezer door, according to requirements.

### Ice tray

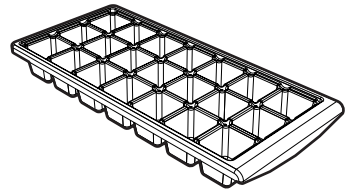

For producing ice cubes; to be placed in the freezer compartment.

**i** The accessories intended to come into contact with food are made of materials that comply with the provisions of current legislation.

**i** Original supplied and optional accessories can be requested to Authorised Assistance Centres. Use only original accessories supplied by the manufacturer.



## 3 Use

### 3.1 Instructions



Improper use

**Risk of damages to the appliance**

- Do not use sharp objects when removing ice and frost in order not to damage the appliance's walls.
- Do not sit or lean on the door or any open drawers.
- Do not touch the heating elements on the outside of the appliance.
- Do not store inflammable, explosive or volatile substances.
- Organic compounds, acids and essential oils can corrode the seals and plastic surfaces if left in contact with them for extended periods.
- Bottles containing strong alcoholic drinks must be tightly closed and stored vertically.

### 3.2 Preliminary operations





1. Remove any protective film from the outside or inside of the appliance, including accessories.
2. Remove any labels (apart from the technical data plate) from the accessories and shelves.
3. Remove and wash all the appliance accessories (see 4 Cleaning and maintenance).

### 3.3 First use



The refrigerator temperature can be set between **+34°F** and **+48°F**.



The freezer temperature can be set between **-9°F** and **+7°F**.

1. Plug the appliance into a wall socket. The  and  symbols are displayed on the temperature and compartment displays.
2. Press the freezer compartment ON/OFF button  (on the left) for 3 seconds to switch on the appliance. The respective green lights come on to indicate that the refrigerator compartment and the freezer compartment are on.
3. The values  and the symbol  for the refrigerator compartment appear on the displays. This value of the temperature will flash on the display until the temperature in the refrigerator drops below this level.



The appliance is set by default to **+41°F** for the refrigerator and **0°F** for the freezer.



#### To set the freezer temperature:

4. Use the freezer temperature button  (on the left) to set the desired temperature. The symbol  (Freezer) will be indicated on the compartment display.



## Use

### To set the refrigerator temperature:

- Use the refrigerator temperature button  (on the right) to set the desired temperature. The symbol  (Refrigerator) will be indicated on the compartment display.
- After approximately 5 seconds of button inactivity, the actual temperature of the compartment will be displayed.



The other buttons are disabled when setting.

### Alarm

The alarm sounds to warn of the following:

**The refrigerator door has been open for more than a minute** (continuous buzzer with relative red light on)

- Press the alarm button  or close the refrigerator door to deactivate the buzzer and switch off the red light.

**The temperature inside the refrigerator or freezer compartment is too high** (intermittent buzzer, flashing display and light on)

- Press the alarm button  to deactivate the buzzer.
- The red light and the flashing temperature on the display turn off automatically when the refrigerator compartment or the freezer compartment reach the previously set temperature.

- If the freezer compartment does not reach the required temperature within 24 hours of the alarm being turned off, it will sound again.







When the appliance is first turned on, the alarm will not sound for the first 24 hours to allow the appliance to reach the set temperatures.

### Control lock



The control lock is a device that protects the appliance from accidental or inappropriate use.

- Press the alarm button  for 3 seconds to turn on the control lock. The  and  symbols appear on the displays.
- Press the alarm button  again for 3 seconds to turn it off.
- Press any other button to return to normal viewing of the display.



When the control lock is active, only the alarm button  is active.



### 3.4 Using the accessories

#### Shelves

These can be positioned at different heights on the guides according to requirements. Each shelf has a safety fitting to prevent it from being accidentally removed. To extract them fully, lift up the front part (1) and remove them (2).

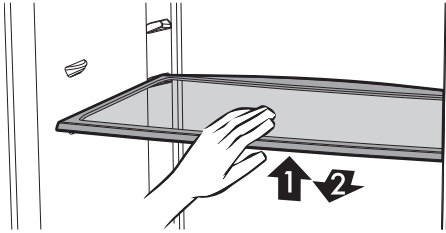

Perishable foods should be placed on the rear part of the shelves where the temperature is lower.

#### Bottle rack

May be positioned at different heights and installed with the front part raised so as to position the bottles at an angle. In order to store particularly long bottles, the bottle rack must be set at a height which will not prevent the door from being closed properly. To extract it fully, lift up the front part and remove it.

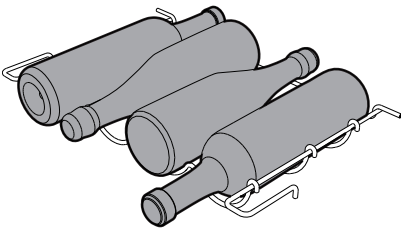

#### Door balconies and shelves

Suitable for storing eggs, butter, dairy products, conserves and other small food packages/containers. The lower part of the door has a shelf for bottles. Avoid placing excessively heavy bottles on the shelf and do not let them drop onto the bottom when inserting them.

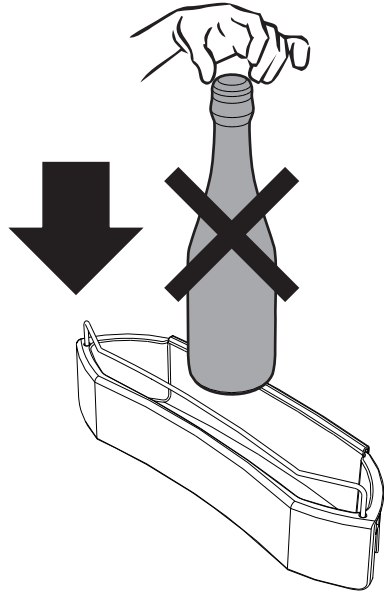

In some models, the internal part of the freezer door is also fitted with balconies for frozen foods which are handled more frequently (e.g. ice cream, already opened bags etc.)



## Use

### Fruit and vegetable drawer

Located at the bottom of the refrigerator compartment, which is fitted with a glass shelf to cover fresh foods that require constant humidity for optimum storage.

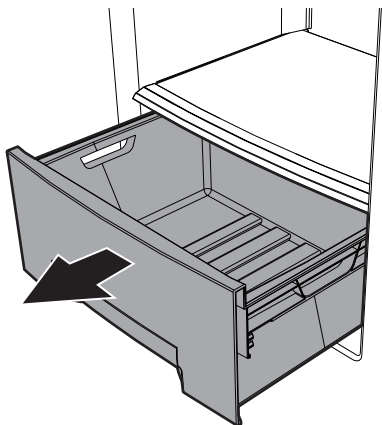

### Freezer drawers

For storing frozen foods and foods to be frozen. To remove them, pull them towards you and lift the front part of each drawer.

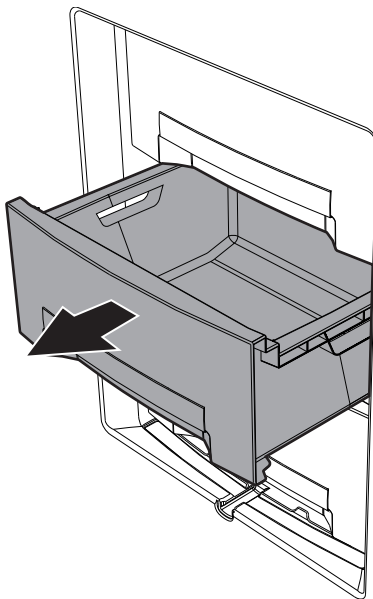

### Ice tray

Fill the ice tray with cold water or other liquids. Place it horizontally in one of the freezer drawers. Close the freezer door and wait a few hours. When the water has fully frozen, remove the tray from the freezer compartment and remove the ice for use.

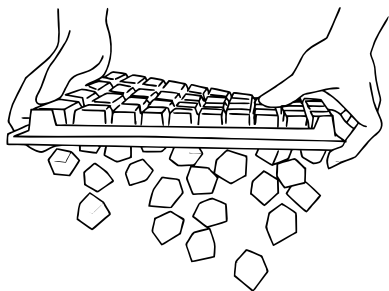



### 3.5 Using the refrigerator compartment

#### Arranging foods

Arrange the foods on the various shelves, taking care that they have an airtight wrapping or cover. This precaution ensures that:

- the flavour, moisture and freshness of the foods is preserved;
- any contamination of foods with odours or tastes from other foods can be avoided;
- the humidity level inside the refrigerator is prevented from becoming too high as a result of the normal transpiration of food (especially fresh fruit and vegetables). In some operating conditions (rise in ambient temperature and humidity, more frequent opening of the door) this might cause condensation to form on the shelves.



Always allow hot foods and drinks to cool to room temperature before putting them in the refrigerator.

#### Super Cool refrigerator Function



The Super Cool refrigerator function is used for quick cooling of large quantities of foodstuffs

1. Press the refrigerator compartment Super Cool ❄️ button. The corresponding orange indicator light comes on.
2. After 6 hours the Super Cool function turns off automatically. The refrigerator compartment returns to its previous setting.

#### Storage life table

Foodstuff	Time
Eggs, smoked meats, marinated foods, cheese	max 10 days
Root vegetables	max 8 days
Butter	max 7 days
Pastries, fruit, ready meals, fresh meat	max 2 days
Fish, minced meat, seafood	max 1 day



## 3.6 Using the freezer compartment

Activate the Super Freeze freezer function 24 hours before freezing fresh foodstuffs.

### Super Freeze Freezer Function



The Super Freeze freezer function is used for quick freezing of large quantities of foodstuffs

1. Press the freezer compartment Super Freeze ❄️ button. The corresponding orange indicator light comes on.
2. When you wish to turn off the Super Freeze function, press the freezer compartment Super Freeze button ❄️ again. The corresponding orange indicator light will turn off.
3. If it is not turned off manually, the Super Freeze function will turn off automatically and the freezer compartment will return to its previous setting.



It is recommended the Super Freeze freezer function be used when first turning the appliance on and before cleaning the freezer.

4. Place the fresh foodstuffs in the freezer drawers.
5. Freeze the foodstuffs in the middle drawer in the No-Frost freezer. After 24 hours, the foodstuffs may be moved to other drawers for storage.

## Frozen foods storage life table

Foodstuff	Time
Fruit, beef	max 10-12 months
vegetables, veal, poultry	max 8-10 months
Game	max 6-8 months
Pork	max 4-6 months
Mince	max 4 months
Bread, desserts, cooked foods, lean fish	max 3 months
Offal	max 2 months
Sausages, oily fish	max 1 month

## Defrosted foods

Food must be consumed as soon as possible once defrosted. Freezing foods preserves them, but it does not destroy any micro-organisms, which are activated after thawing, damaging the foods.

Partial defrosting lowers the nutritional value of the foodstuffs, particularly of fruit, vegetables and ready meals.





### 3.7 Noises during operation

The refrigerator and freezer compartments are cooled by means of a compression system. In order to maintain the preset temperature inside the refrigerator and freezer compartments, the compressor comes into operation in response to the level of cooling required, and may operate continuously if necessary. When the compressor starts to function, it creates a buzzing noise which generally diminishes in intensity after a few minutes.

Another normal operating noise of the appliance is a gurgling due to the coolant flowing through the pipes in the circuit. This noise is normal and does not indicate an appliance malfunction. If it becomes too loud, this may mean that there are other causes. Checks must then be made to ensure that:



- The refrigerator is properly levelled on the floor and does not vibrate when the compressor is in operation: if this is not the case, adjust the appliance's feet until it is level;
- The drawers, shelves and trays on the door are correctly positioned in their holders: if they are not, put them in correctly;
- Bottles and containers on the various shelves are stable and not touching each other: otherwise, the vibration resulting from compressor operation could generate noise;
- Do not position the refrigerator in such a way that it is in contact with furniture or other household appliances.

### 3.8 Heated front surface

There is a front surface heating system inside the cabinet to limit the formation of condensation around the door seal.

### 3.9 Turning the appliance off

Whenever the appliance is to remain unused for long periods, it should be switched off.

1. Press the freezer compartment ON/OFF button  (on the left of the control panel) for 3 seconds. The respective green lights turn off to indicate that the refrigerator compartment and the freezer compartment are off.
2. The  and  symbols are displayed on the temperature and compartment displays.
3. Unplug the appliance from the wall socket.
4. Empty the compartments.
5. Once the freezer has fully defrosted, dry any residual accumulated moisture with a tea towel.
6. Leave the door ajar to ensure that moisture and stagnant air do not cause unpleasant odours.



It is possible to turn off just the refrigerator if required. Press the refrigerator ON/OFF button  (on the right) for 3 seconds



## 3.10 Food storage advice

### Practical energy saving advice

- Correct use of the appliance, correct packaging of foodstuffs, a constant temperature and food hygiene have significant effects on the quality of storage.
- Reduce the number of times that the doors are opened and the length of time they remain open to prevent the compartments from heating up excessively.
- Clean the condenser (rear of the refrigerator) periodically to prevent the appliance from losing efficiency.
- Use the Super Freeze function only when strictly necessary.
- Defrost frozen food in the refrigerator compartment in order to make use of the cold stored in the frozen foods.

### General advice

- Always check the expiry date on the food packaging.
- The foodstuffs must be stored in closed or pre-packaged containers and must not be able to emit or absorb moisture and odours.
- Remove perishable products from the appliance if you are going away for a long period.

### Refrigerator compartment door

- Keep eggs, butter, cheese etc. in the upper and central parts.
- Keep drinks, bottles, cans etc. in the lower part.

### Refrigerator compartment

- Keep preserves, wine, biscuits etc. in the upper part.
- Keep dairy products, ready meals, pastries, fruit juices, beer etc. in the central part.
- Keep meats, cold cuts etc. in the lower part.
- Keep fresh and tropical fruit, vegetables, root vegetables etc. in the fruit and vegetable drawer.



## **Freezer compartment**

- The type of food, quantity and date of freezing should be marked on the container/packaging.
- Use small containers, if possible already cold.
- The quantity of fresh foods which can be frozen at the same time is listed on the nameplate inside the refrigerator compartment.
- Use suitable freezer bags, tinfoil, cling-film for use with food, and freezer containers.
- Do not use paper bags, cellophane for non-food use, shopping bags or pre-used freezer bags.
- Avoid frozen food coming into contact with fresh food to be frozen.

## **Freezer compartment door (only static models)**

- Keep bagged frozen vegetables, ice, ice cream etc.



## 4 Cleaning and maintenance

### 4.1 Instructions



#### Improper use Risk of damage to surfaces

- Do not use steam jets for cleaning the appliance.
- Do not use cleaning products containing chlorine, ammonia or bleach on steel parts or parts with metallic finishes on the surface (e.g. anodizing, nickel- or chromium-plating).
- Do not use abrasive or corrosive detergents on glass parts (e.g. powder products, stain removers and metallic sponges).
- Do not use rough or abrasive materials or sharp metal scrapers.



#### Power voltage Danger of electrocution

- Turn off the appliance and unplug it from the mains before cleaning.
- Do not pull the cable to remove the plug.

### 4.2 Cleaning the appliance

A special antibacterial protection on the appliance's interior walls prevents bacterial growth and keeps them clean. They must nevertheless be cleaned regularly in order to keep them in good condition.

#### Cleaning the outside of the appliance

- The appliance may be cleaned with water or alcohol-based liquid detergents (e.g. window cleaning products).
- Avoid aggressive detergents and rough sponges in order not to damage the surfaces.
- Use a soft brush to remove dust and fume deposits from the condenser on the rear of the appliance.
- Clean the tank above the compressor.

#### Cleaning the inside of the appliance

- Clean the interior with diluted liquid detergent or with warm water with a little vinegar added.
- The door balconies and containers can be removed: tap them upwards with your fist, first on one side and then on the other in the insertion zone.
- Remove any ice thicker than 3-5 mm. Do not use sharp objects or spray products.



## 4.3 Defrosting



No-Frost models perform this procedure automatically. Occasional presence of frost inside the freezer compartment is normal.

### Defrosting the refrigerator compartment

The refrigerator compartment does not require defrosting, as any ice which forms on the refrigeration plate will melt when the compressor is idle.

If ice thicker than 3-5 mm should form on the inside walls of the refrigerator compartment, turn off the appliance and defrost it manually.

The drainage channel opening for melted ice is located inside the refrigerator compartment under the refrigeration plate. Check regularly that it is not blocked by food scraps or anything else and clean it if necessary with a straw or stiff wire.

## 4.4 Replacing the lamp

1. Remove the bulb cover using a tool (e.g. a screwdriver).

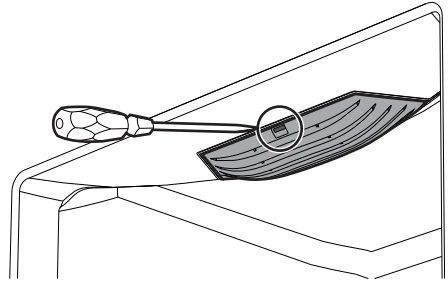

2. Unscrew and remove the lamp.

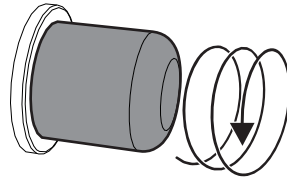

3. Replace the lamp with one of the same type.



Use only bulbs max 3.3W.

4. Refit the cover: line up the teeth of the cover with the slots in the back of the lamp housing, then close the cover.

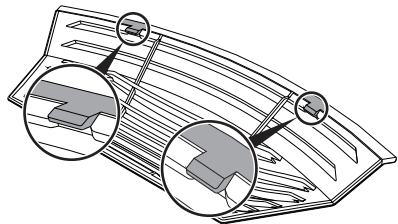



## Cleaning and maintenance

### 4.5 What to do if...

The appliance does not work:

- Make sure that the appliance is plugged in and that the main switch is turned on.

The compressor starts to function too often or functions continuously:

- The room temperature is too high.
- The door is being opened too often or for too long.
- The door is not closing/sealing properly.
- The freezer is loaded with too many fresh foods.
- Check that sufficient air can circulate around the sensor on the right-hand side of the refrigerator compartment.
- Check that the back of the freezer is properly ventilated and that the condenser is not too dirty.

Excessive ice or condensation has built up inside the refrigerator compartment:

- The door is being opened too often or for too long.
- Hot foods have been placed inside the refrigerator compartment.
- The foodstuffs or containers are in contact with the rear wall.
- The door seal is damaged or dirty. Clean or replace it.

Water is forming inside the refrigerator compartment:

- The drainage channel or opening is blocked.

The refrigerator compartment is not sufficiently cold:

- The thermostat is set at too high a temperature.
- The door is being opened too often or for too long.
- The door is not closing/sealing properly.
- The room temperature is too high.



The temperature inside the refrigerator compartment is too cold and the foodstuffs are freezing.

- The thermostat is set at too low a temperature.
- Foodstuffs not contained in suitable containers or bags.
- Fruit and vegetables might be too wet.
- Foodstuffs placed against the rear wall of the refrigerator compartment.

Temperature inside freezer compartment not low enough to freeze foods properly:

- The thermostat is set at too high a temperature.
- The door is being opened too often or for too long.
- The door is not closing/sealing properly.
- The door seal is damaged or dirty. Clean or replace it.
- The food to be frozen contains large quantities of sugar.

Excessive ice has built up inside the freezer compartment:

- The thermostat is set at too low a temperature.
- The room temperature is too high.
- The door is being opened too often or for too long.
- The door is not closing/sealing properly.
- The door seal is damaged or dirty. Clean or replace it.
- Hot foods have been placed inside the freezer compartment.

Door hard to open just after closing:

- If you attempt to open the door again just after closing it (especially the freezer door), considerable strength is required. This is due to the vacuum created by the cooling of the warm air which has entered the freezer.

The doors are misaligned:

- Check that the appliance is level.
- Level the appliance using its feet.

The following **E1** appears on the display:

- Call Technical Support.



# Installation

## 5 Installation

### 5.1 Unpack the refrigerator



**Heavy appliance  
Danger of crush injuries**

- Use two or more people to move and install refrigerator. Failure to do so can result in back or other injury.

### Remove the packaging

- Remove tape and glue residue from surfaces before turning on the refrigerator. Rub a small amount of liquid dish soap over the adhesive with your fingers. Wipe with warm water and dry.
- Do not use sharp instruments, rubbing alcohol, flammable fluids, or abrasive cleaners to remove tape or glue. These products can damage the surface of your refrigerator.
- On some models, shelves, bins, door shelf rails, and other feature parts may be packaged in the Interior FeaturePak. Follow the instructions contained in the package for proper assembly.
- Properly dispose of packaging.

### When moving your refrigerator

- Your refrigerator is heavy. When moving the refrigerator for cleaning or service, be sure to protect the floor.
- Always pull the refrigerator straight out when moving it.
- Do not wiggle or “walk” the refrigerator when trying to move it, as floor damage could occur.

### Clean before using

After you remove all of the package materials, clean the inside of your refrigerator before using it.

### Glass shelves and covers

Do not clean glass shelves or covers with warm water when they are cold. Shelves and covers may break if exposed to sudden temperature changes or impact, such as bumping.

For your protection, tempered glass is designed to shatter into many small, pebble-size pieces. This is normal. Glass shelves and covers are heavy. Use special care when removing them to avoid impact from dropping.





## 5.2 Positioning



### Heavy appliance Danger of crush injuries

- Position the appliance with the aid of a second person.



### Pressure on the open door Risk of damages to the appliance

- Never use the open door to lever the appliance into place when fitting.
- Avoid exerting too much pressure on the door when open.
- The appliance must not be exposed to direct sunlight.
- The appliance must not be installed near heat sources. If this is not possible, suitable insulation must be used.
- Do not use the appliance outdoors.

## Choice of location

- Always install the refrigerator in a dry place with satisfactory ventilation.
- Install the appliance at least 3 cm away from electrical or gas cookers and at least 30 cm away from combustion heaters or radiators.
- The appliance must not be installed near heat sources. If this is not possible, suitable insulation must be used.
- If installed underneath wall units, at least 5 cm clearance must be left.
- Ensure that the appliance is located with sufficient space for the door to open and for the internal drawers and shelves to be removed, if necessary.



# Installation

- To allow proper cooling of the condenser, the refrigerator must not be placed too close to the wall. To prevent this, the appliance comes complete with two plastic spacers which must be fitted to the top of the condenser.

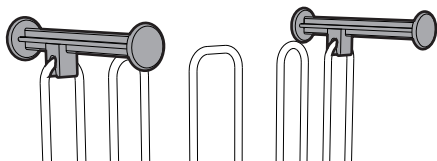

## Positioning

Place the appliance on a stable and level floor. If the floor is not perfectly level, use the two adjustable feet on the front part of the appliance.

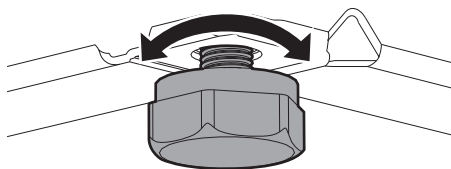

The appliance has two small wheels on the back to allow it to be moved and positioned more easily.

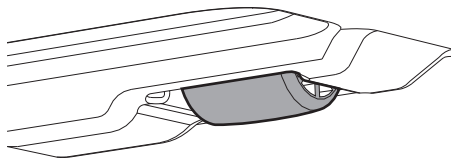

In any case, we recommend moving the appliance very carefully in order to avoid damaging the floor (especially in the case of wooden floors).

## 5.3 Electrical connection



**Power voltage  
Danger of electrocution**

- The appliance must be connected to earth in compliance with electrical system safety standards.
- Do not pull the cable to remove the plug.

## General information

- Check the grid characteristics against the data indicated on the plate. The identification plate bearing the technical data, serial number and brand name is visibly positioned inside the appliance. Do not remove this plate for any reason.
- Make sure that the plug and socket are of the same type.
- Avoid using adapters and shunts as these could cause overheating and a risk of burns.
- The plug must always be accessible when the appliance is installed.
- Leave the refrigerator standing vertically for at least two hours before turning it on for the first time.
- If it is necessary to replace the power cable, **this must be performed by an authorised technician from Technical Support Service.**